



**OPAL-RT**

# **OP5360-2 USER MANUAL**

**5 to 30V  
32 Digital Output Module**

**Published by**







Opal-RT Technologies, Inc. 1751 Richardson, suite 2525 Montréal (Québec) Canada H3K 1G6

[www.opal-rt.com](http://www.opal-rt.com)

---

## SYMBOL DEFINITIONS

The following table lists the symbols used in this document to denote certain conditions:

Symbol	Definition
	ATTENTION: Identifies information that requires special consideration
	TIP: Identifies advice or hints for the user, often in terms of performing a task
	REFERENCE _ INTERNAL: Identifies an additional source of information within the bookset.
<b>CAUTION</b>	Indicates a situation which, if not avoided, may result in equipment or work (data) on the system being damaged or lost, or may result in the inability to properly operate the process.
	Indicates a situation where users must observe precautions for handling electrostatic sensitive devices.
	CAUTION: Indicates a potentially hazardous situation which, if not avoided, may result in minor or moderate injury. It may also be used to alert against unsafe practices.
	WARNING: Indicates a potentially hazardous situation which, if not avoided, could result in serious injury or death.



---

# CONTENTS

**OP5360-2, 32 DOUT** ..... 9

    FEATURES.....9

    RECOMMENDATIONS .....10

    APPLICATIONS .....10

DB37F PIN ASSIGNMENTS..... 10

SPECIFICATIONS ..... ..



## OP5360-2, 32 DOUT

The OP5360-2 type B module provides 32 isolated Push-Pull DOUT divided in two banks of 16. Each bank can be separately powered by the user. The board can accept up to 30Vdc and can sink or source 50 mA dc (recommended) with no trip action.



Higher currents will trip the current protection and all the output levels provided in this datasheet will not be applicable

The OP5360-2 is ideal for high-frequency (up to 500 KHz) and voltage applications from 15V to 30V.

### FEATURES

- 32 DOUT push-pull
- Wide operating voltage range:  $V_{user}$  5 Vdc to max 30 Vdc
- Load current up to 50 mA DC per output
- OV and reverse voltage supply protection
- Short-circuit current limitation
- Operating frequency DC-500Khz
- Low ON/OFF time propagation delay:  $\leq 200\text{ns}$  @ 25°C at 5 V
- Low ON/OFF time propagation delay:  $\leq 65\text{ns}$  @ 25°C from 15 to 30 V
- Outputs are tri-stated.
- Outputs may be connected in parallel for higher (2 times) current capability
  - Use matched pair (example: DOUT\_0 with 1 , DOUT\_2 with 3, etc.)

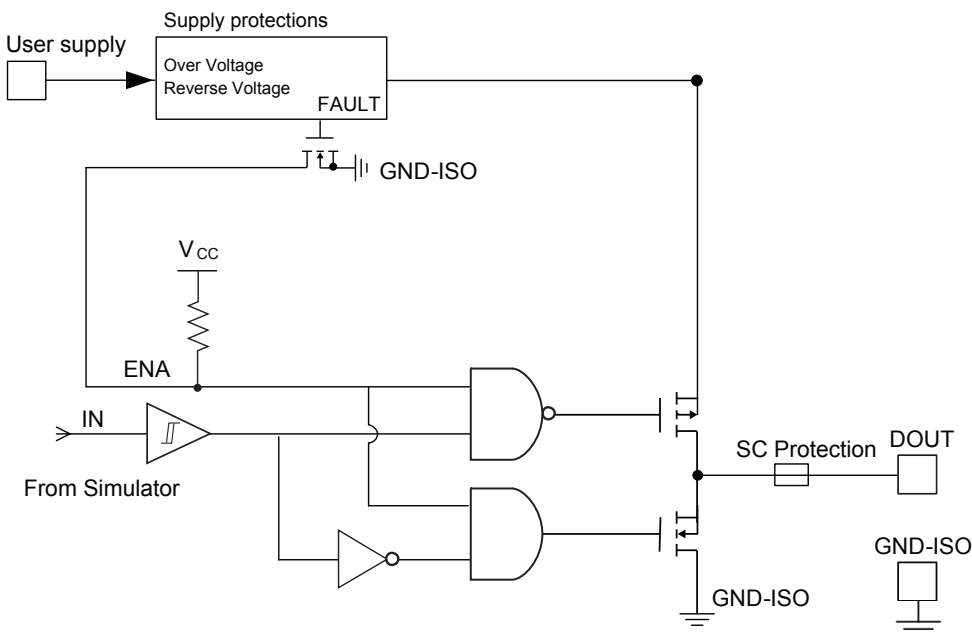

Figure 1: OP5360-2 bloc diagram

## RECOMMENDATIONS

Users should adjust the power supply level (through the DB37 connector) to get the proper high voltage level at the DOUT.

Use a proper damping circuit, (a serial resistor capacitor circuit tied to the GND as close as possible to the user Device Under Test) to minimize ringing and over/undershoot according to the connection length (from OP5360-2 to user DUT).

The following parameters are a good starting point for the RC values:  $R=150\Omega$  ,  $C = 100\text{pF}$ . Tuning is necessary, according to application parameters.

## APPLICATIONS

- Efficient power MOSFET and IGBT Sswitching
- Switch-mode power supplies
- DC-to-DC converters
- Motor control, solar power

## DB37F PIN ASSIGNMENTS

Connector P1 Ch. 0-15				Connector P2 Ch. 16-31			
DB37F	OP5360-1 pin assignment	DB37F	OP5360-1 pin assignment	DB37F	OP5360-1 pin assignment	DB37F	OP5360-1 pin assignment
1	+DOUT00	20	-DOUT00	1	+DOUT16	20	-DOUT16
2	+DOUT01	21	-DOUT01	2	+DOUT17	21	-DOUT17
3	+DOUT02	22	-DOUT02	3	+DOUT18	22	-DOUT18
4	+DOUT03	23	-DOUT03	4	+DOUT19	23	-DOUT19
5	+DOUT04	24	-DOUT04	5	+DOUT20	24	-DOUT20
6	+DOUT05	25	-DOUT05	6	+DOUT21	25	-DOUT21
7	+DOUT06	26	-DOUT06	7	+DOUT22	26	-DOUT22
7	+DOUT07	27	-DOUT07	8	+DOUT23	27	-DOUT23
9	+DOUT08	28	-DOUT08	9	+DOUT24	28	-DOUT24
10	+DOUT09	29	-DOUT09	10	+DOUT25	29	-DOUT25
11	+DOUT10	30	-DOUT10	11	+DOUT26	30	-DOUT26
12	+DOUT11	31	-DOUT11	12	+DOUT27	31	-DOUT27
13	+DOUT12	32	-DOUT12	13	+DOUT28	32	-DOUT28
14	+DOUT13	33	-DOUT13	14	+DOUT29	33	-DOUT29
15	+DOUT14	34	-DOUT14	15	+DOUT30	34	-DOUT30
16	+DOUT15	35	-DOUT15	16	+DOUT31	35	-DOUT31
17		36		17		36	
18	Vuser 1	37	Vrtn 1	18	Vuser 2	37	Vrtn 2
19				19			

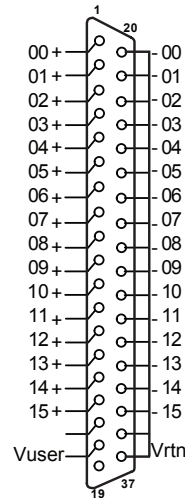



## SPECIFICATIONS

<b>Product name</b>	<b>OP5360-2 (32 digital outputs - push-pull)</b>
Part number	126-0466
Number of channels	32 digital outputs 2 banks of 16, fully isolated and independent of each other
Isolation	Galvanic isolator
Output Protection	50 mA resettable fuse
Protection thresholds	Over voltage: 30V $\pm$ 5% Under voltage protection 5V $\pm$ 2.5% Reverse voltage: maximum 30 V.
Output Voltage range	5 to 30 Vdc max
Output configuration	Push-pull, tri-state output
Delay Low-to-High	$\leq$ 65ns @ 25°C for 30 V $\leq$ 200ns @ 25°C for 5 V
Delay High-to-Low	$\leq$ 65ns @ 25°C for 30 V $\leq$ 200ns @ 25°C for 5 V
Rise/Fall times	$\leq$ 15 ns
Form factor	Mezzanine Type B
Dimensions	6.60 cm x 12.50 cm (2.6" x 4.92")
I/O connector	80-pin high speed header to carrier
Operating temperature	10 to 40 °C (50 to 104°F)
Storage temperature	-55 to 85°C (-67 to 185°F)
Relative humidity	10 to 90%, non condensing
Maximum altitude	2,000 m (6562 ft.)



## **CONTACT**

### **OPAL-RT Corporate Headquarters**

1751 Richardson, Suite 2525  
Montréal, Québec, Canada  
H3K 1G6  
Tel.: 514-935-2323  
Toll free: 1-877-935-2323

### **Technical Services**

[www.opal-rt.com/support](http://www.opal-rt.com/support)

## **Note:**

**While every effort has been made to ensure accuracy in this publication, no responsibility can be accepted for errors or omissions. Data may change, as well as legislation, and you are strongly advised to obtain copies of the most recently issued regulations, standards, and guidelines.**

**This publication is not intended to form the basis of a contract.**



**OPAL-RT**

**UG 14-42287-1-RVN\_4.0**

**11/2015**

**© OPAL-RT Technologies Inc.**